

**SERIES: VSK-S15-T | DESCRIPTION: AC-DC POWER SUPPLY**
**FEATURES**

- up to 15W continuous power
- compact chassis mount design
- universal input (85~264 Vac / 100~370 Vdc)
- single output from 3.3~48 Vdc
- over voltage, over current, and short circuit protections
- UL/cUL safety approvals
- efficiency up to 85%

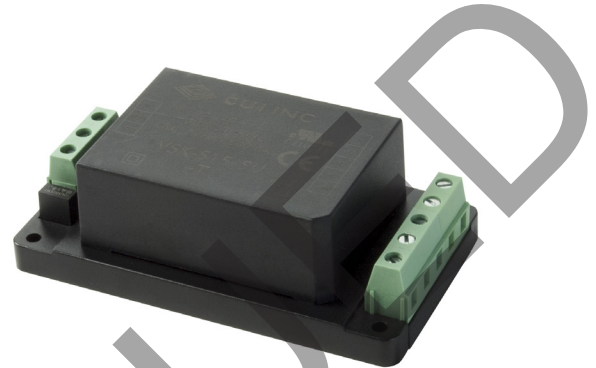

MODEL	output voltage	output current max	output power max	ripple and noise <sup>1</sup>	efficiency
	(Vdc)	(A)	(W)	typ (mVp-p)	typ (%)
VSK-S15-3R3U-T	3.3	3	9.9	50	73
VSK-S15-5U-T*	5	2.8	14	50	76
VSK-S15-9U-T*	9	1.6	14.4	50	78
VSK-S15-12U-T*	12	1.25	15	50	80
VSK-S15-15U-T*	15	1.0	15	50	80
VSK-S15-24U-T*	24	0.625	15	50	84
VSK-S15-48U-T*	48	0.32	15	50	85

Notes: 1. Ripple and noise are measured at 20 MHz BW by "parallel cable" method with 1 uF ceramic and 10 uF electrolytic capacitors on the output.  
 \*. Discontinued model

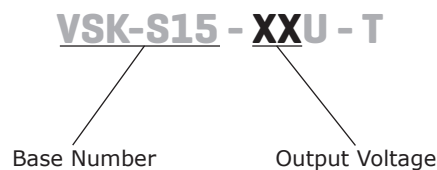
**PART NUMBER KEY**

**INPUT**

parameter	conditions/description	min	typ	max	units
voltage		85		264	Vac
		100		370	Vdc
frequency		47		63	Hz
current	at 115 Vac			370	mA
	at 230 Vac			220	mA
inrush current	at 115 Vac		10		A
	at 230 Vac		20		A
leakage current	at 230 Vac, 50 Hz (RMS)		0.1		mA
input fuse	2 A/250 V, slow-blow type (included on chassis)				

**OUTPUT**

parameter	conditions/description	min	typ	max	units
capacitive load	3.3 Vdc output model			36,000	μF
	5 Vdc output model			20,000	μF
	9 Vdc output model			6,000	μF
	12 Vdc output model			3,000	μF
	15 Vdc output model			3,000	μF
	24 Vdc output model			900	μF
	48 Vdc output model			370	μF
line regulation	at full load		±0.5		%
load regulation	at 10~100% load		±1		%
voltage set accuracy			±2		%
hold-up time	at 115 Vac		15		ms
	at 230 Vac		80		ms
switching frequency			65		kHz
temperature coefficient			±0.02		%/°C

**PROTECTIONS**

parameter	conditions/description	min	typ	max	units
over current protection	auto restart	110			%
short circuit protection	continuous, auto restart				
over voltage protection	3.3 Vdc output model			7.5	Vdc
	5 Vdc output model			7.5	Vdc
	9 Vdc output model			12	Vdc
	12 Vdc output model			20	Vdc
	15 Vdc output model			20	Vdc
	24 Vdc output model			30	Vdc
	48 Vdc output model			60	Vdc

**SAFETY & COMPLIANCE**

parameter	conditions/description	min	typ	max	units
isolation voltage	input to output for 1 minute	3,000			Vac
safety approvals	UL60950-1, CE				
safety class	class II				
conducted emissions	CISPR22/EN55022, Class B				
radiated emissions	CISPR22/EN55022, Class B				
ESD	IEC/EN61000-4-2 Class B, contact ±6 kV/air ±8 kV				
radiated immunity	IEC/EN61000-4-3 Class A, 10V/m				
EFT/burst	IEC/EN61000-4-4 Class B, ±2 kV				
	IEC/EN61000-4-4 Class B, ±4 kV (external circuit required, see figure 2)				

**SAFETY & COMPLIANCE (CONTINUED)**

parameter	conditions/description	min	typ	max	units
surge	IEC/EN61000-4-5 Class B, $\pm 1$ kV/ $\pm 2$ kV IEC/EN61000-4-5 Class B, $\pm 2$ kV/ $\pm 4$ kV (external circuit required, see figure 2)				
conducted immunity	IEC/EN61000-4-6 Class A, 10 Vr.m.s				
PFM	IEC/EN61000-4-8 Class A, 10 A/m				
voltage dips & interruptions	IEC/EN61000-4-11 Class B, 0%-70%				
MTBF	as per MIL-HDBK-217F at 25°C	300,000			hrs
RoHS	2011/65/EU				

**ENVIRONMENTAL**

parameter	conditions/description	min	typ	max	units
operating temperature	see derating curves	-40		70	°C
storage temperature		-40		105	°C
storage humidity	non-condensing			95	%

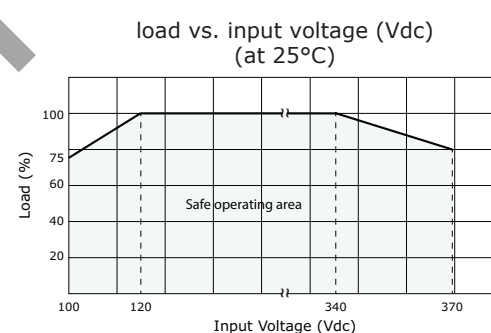
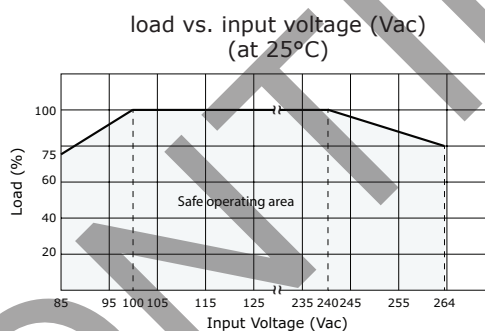
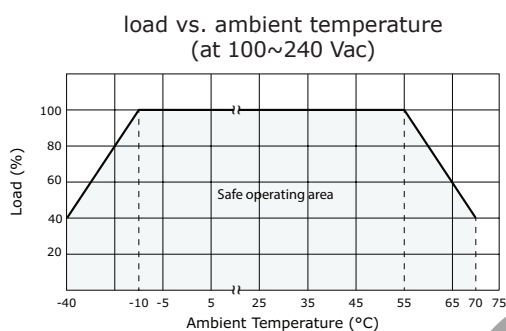
**DERATING CURVES**

**MECHANICAL**

parameter	conditions/description	min	typ	max	units
dimensions	96.10 x 54.00 x 31.00 (3.783 x 2.126 x 1.22 inch)				mm
case material	UL94V-0				
weight			135		g
cooling	convection cooling				

**MECHANICAL DRAWING**

units: mm[inches]

tolerance:  $\pm 0.50[\pm 0.020]$ 

wire range: 24~12 AWG

PIN CONNECTIONS	
PIN	FUNCTION
1	NC
2	AC(N)
3	AC(L)
4	-Vo
5	NC
6	NC
7	NC
8	+Vo

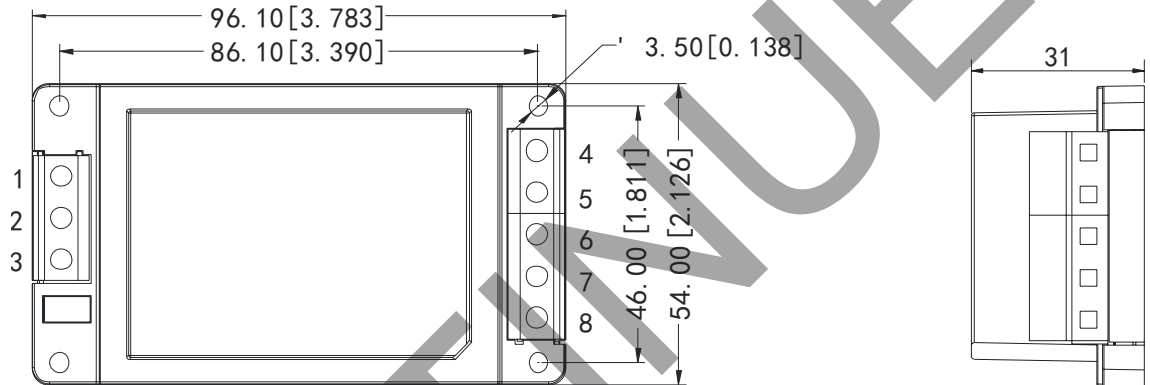

Top View

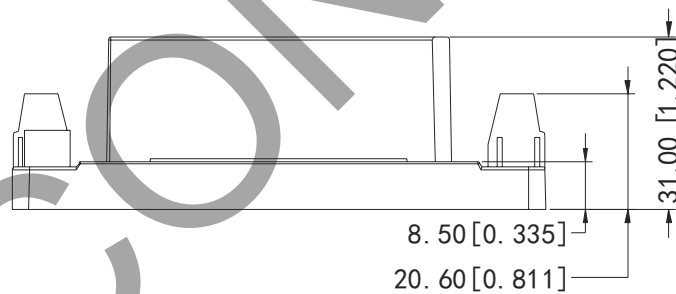

Side View

## TYPICAL APPLICATION CIRCUIT

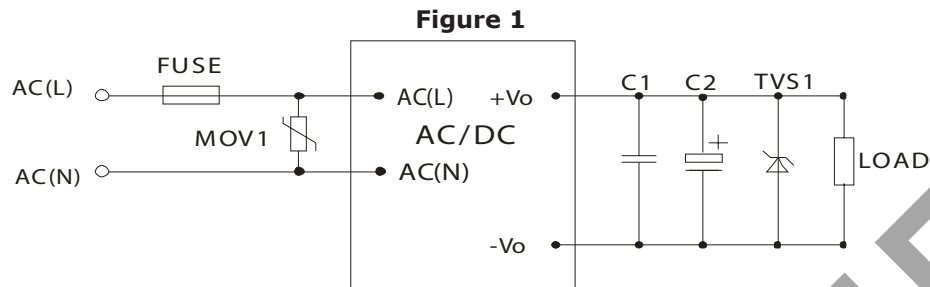
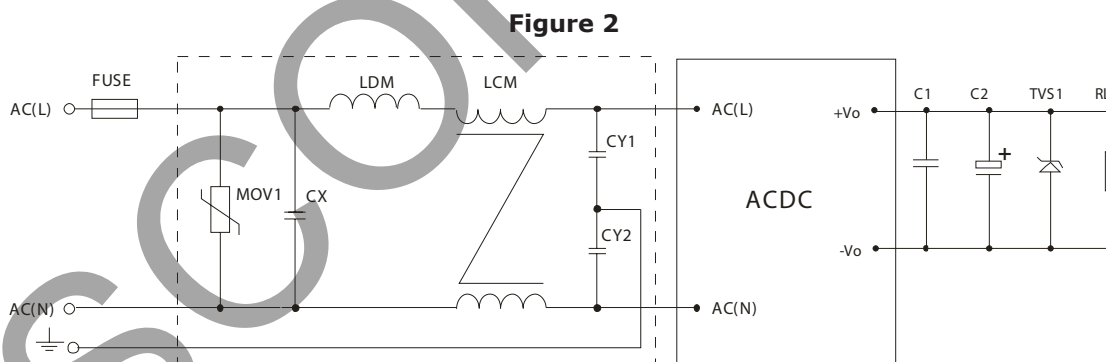

**Table 1**

Recommended External Circuit Components					
MODEL	FUSE <sup>1</sup>	MOV1	C1	C2	TVS
VSK-S15-3R3U-T	2A/250V	S14K350	1 $\mu$ F	680 $\mu$ F	SMBJ7.0A
VSK-S15-5U-T	2A/250V	S14K350	1 $\mu$ F	680 $\mu$ F	SMBJ7.0A
VSK-S15-9U-T	2A/250V	S14K350	1 $\mu$ F	470 $\mu$ F	SMBJ12A
VSK-S15-12U-T	2A/250V	S14K350	1 $\mu$ F	220 $\mu$ F	SMBJ20A
VSK-S15-15U-T	2A/250V	S14K350	1 $\mu$ F	220 $\mu$ F	SMBJ20A
VSK-S15-24U-T	2A/250V	S14K350	1 $\mu$ F	68 $\mu$ F	SMBJ30A
VSK-S15-48U-T	2A/250V	S14K350	1 $\mu$ F	33 $\mu$ F	SMBJ64A

Note: 1. Fuse included on chassis

## EMC RECOMMENDED CIRCUIT



**Table 2**

Recommended External Circuit Components	
MOV1	S14K350
CY1, CY2	1000pF/400Vac
CX	0.1 $\mu$ F/275Vac
LCM	10mH
LDM	4.7 $\mu$ H/2A

Note: Also refer to Table 1

Notes: 1. Output filtering capacitor C2 is an electrolytic capacitor, It is recommended to use high frequency and low impedance electrolytic capacitors. For capacitance and current of capacitor please refer to manufacture's datasheet. Voltage derating of capacitor should be 80% or above. C1 is used to filter high frequency noise. TVS is recommended component to protect post-circuits (when converter fails).  
2. All specifications measured at Ta=25C, humidity <75%, nominal input voltage, and rated output load, unless otherwise specified.

## REVISION HISTORY

rev.	description	date
1.0	initial release	09/06/2012
1.01	corrected pinout	10/21/2013
1.02	updated spec	08/20/2014
1.03	updated operating and storage temperatures	06/10/2015
1.04	company logo updated	10/29/2020
1.05	discontinued model VSK-S15-15U-T, VSK-S15-24U-T, VSK-S15-48U-T, VSK-S15-5U-T, VSK-S15-9U-T	11/11/2022

The revision history provided is for informational purposes only and is believed to be accurate.



**CUI INC**

a bel group

**Headquarters**

20050 SW 112th Ave.  
Tualatin, OR 97062  
**800.275.4899**

Fax 503.612.2383  
**cui.com**  
techsupport@cui.com

CUI offers a two (2) year limited warranty. Complete warranty information is listed on our website.

CUI reserves the right to make changes to the product at any time without notice. Information provided by CUI is believed to be accurate and reliable. However, no responsibility is assumed by CUI for its use, nor for any infringements of patents or other rights of third parties which may result from its use.

CUI products are not authorized or warranted for use as critical components in equipment that requires an extremely high level of reliability. A critical component is any component of a life support device or system whose failure to perform can be reasonably expected to cause the failure of the life support device or system, or to affect its safety or effectiveness.