

SERIES: EPS 6W | **DESCRIPTION:** AC-DC POWER SUPPLY

FEATURES

- up to 6 W power
- compact size
- single output from 3~24 V
- over voltage and short circuit protections
- custom designs available



MODEL	output voltage	output current max	output power max	ripple and noise ¹ max	efficiency level
	(Vdc)	(A)	(W)	(mVp-p)	
EPS030100	3	1	3	100	IV
EPS033100	3.3	1	3.3	100	IV
EPS045100	4.5	1	4.5	100	V
EPS050100	5	1	5	100	V
EPS060100	6	1	6	100	V
EPS075080	7.5	0.8	6	100	IV
EPS090066	9	0.66	6	100	V
EPS120050	12	0.5	6	120	V
EPS150040	15	0.4	6	150	V
EPS180033	18	0.33	6	180	V
EPS240025	24	0.25	6	240	IV

Notes: 1. At full load, 100 ~ 132 Vac input, 20 MHz bandwidth oscilloscope, each output terminated with 10 μ F aluminum electrolytic and 0.1 μ F ceramic capacitors.

PART NUMBER KEY

EPS030100 - PXXXX - CXX

Base Number
example of 3 Vdc, 1 A

DC Plug Type

Reserved for Custom
Configurations

INPUT

parameter	conditions/description	min	typ	max	units
voltage		100		132	Vac
frequency		47		63	Hz
current				0.15	A
inrush current ¹	15V, 18V and 24V model	at 100 Vac at 132 Vac		15 30	A A
	all other models	at 132 Vac		40	A
	level IV models level V models			0.5 0.3	W W

Notes: 1. inrush lasts no longer than 0.5 ms before settling to steady state current

OUTPUT

parameter	conditions/description	min	typ	max	units
line regulation	all other models		±1		%
	7.5V model		±2		%
load regulation			±5		%
temperature coefficient	0 ~ 40°C, full load, after initial 1 hour warm-up		±0.02		%/°C
start-up	time needed to reach regulation			3	s
hold-up	at 115 Vac, full load	10			ms

PROTECTIONS

parameter	conditions/description	min	typ	max	units
over voltage protection	clamped by internal protection zener				
short circuit protection	continuous, auto-recovery upon removal of short				

SAFETY & COMPLIANCE

parameter	conditions/description	min	typ	max	units
isolation voltage	input to output at 10 mA for 1 minute			3,000	Vdc
				4,242	Vdc
isolation resistance	input to output at 500 Vdc	100			MΩ
safety approvals	UL 1310				
safety	class II				
EMI/EMC	FCC Part 15 Class B				
leakage current				0.25	mA
RoHS compliant	yes				

ENVIRONMENTAL

parameter	conditions/description	min	typ	max	units
operating temperature		0		40	°C
storage temperature		-10		70	°C
operating humidity		20		80	%
storage humidity		10		90	%

MECHANICAL

parameter	conditions/description	min	typ	max	units
dimensions	62.33 x 26.8 x 42 (2.454 x 1.055 x 1.654 inch)				mm
input plug	fixed US				

MECHANICAL DRAWING

units: mm
 tolerance: X.X ±0.5
 X.XX ±0.03

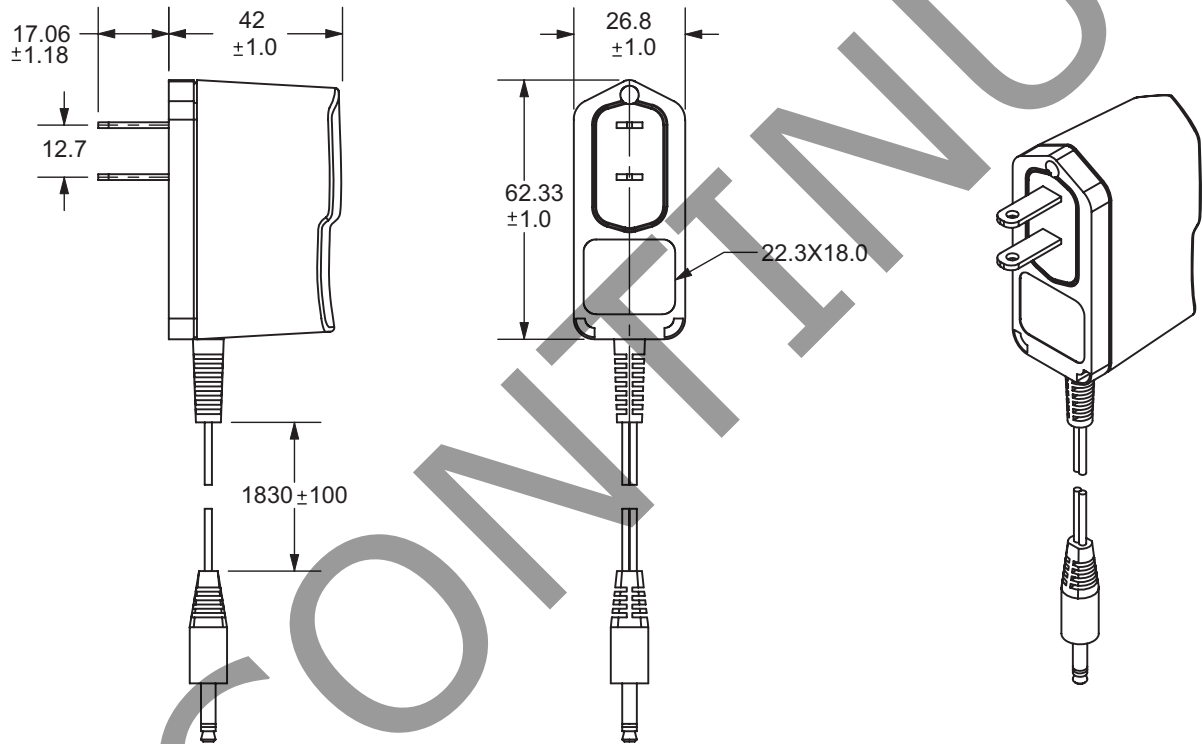

OUTPUT PLUG OPTIONS

3.5 mm Phono Plug

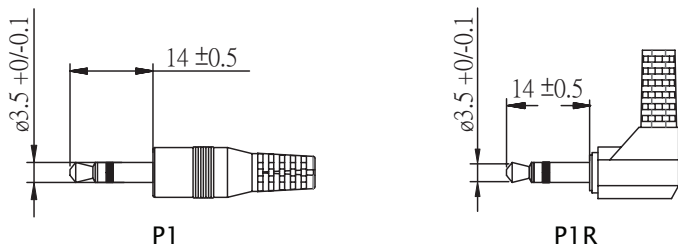

Standard DC Plug

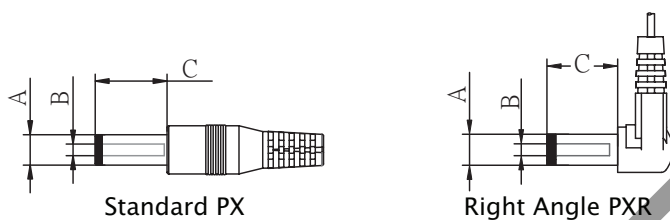

	A	B	C	Unit
P5/P5R	5.5	2.1	12 ¹	mm
P6/P6R	5.5	2.5	12	mm
P7/P7R	3.5	1.35	9.5	mm
P8/P8R	3.8	1.35	9.5	mm
P9/P9R	3.8	1.05	9.5	mm

Notes: 1. EPS050100-P5P has a 9.5mm dc plug length

Locking DC Plug

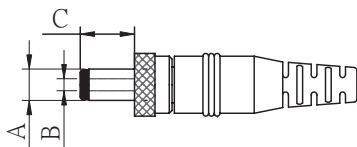

	A	B	C	Unit
P10	5.5	2.1	9.5	mm
P11	5.5	2.5	9.5	mm

EIAJ Plugs

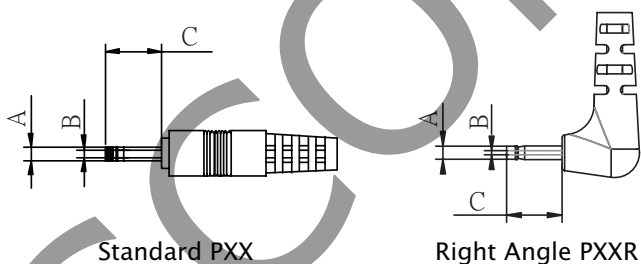

	EIAJ	A	B	C	D	Unit
P12/P12R	EIAJ-1	2.35	0.7	9.5	NA	mm
P13/P13R	EIAJ-2	4.0	1.7	9.5	5.0	mm
P14/P14R	EIAJ-3	4.75	1.7	9.5	5.0	mm

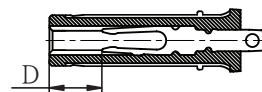

Stripped and Tinned

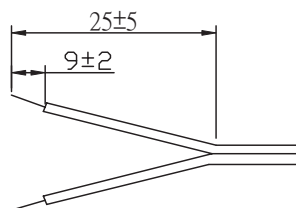



DC PLUG TYPE

ST
|
stripped and tinned

PXX X X

Plug type

Plug angle:
"blank" = standard
R = right angle

Plug polarity:
"blank" = N/A
P = center positive 
N = center negative 

REVISION HISTORY

rev.	description	date
1.0	initial release	06/29/2006
1.01	applied new spec template	12/28/2010
1.02	removed multiple models, applied new spec template	05/26/2011
1.03	updated P7/P7R B dimension	04/13/2012
1.04	V-Infinity branding removed, safety and EMI/EMC data updated	08/16/2012
1.05	added 7.5V model	09/24/2012
1.06	updated P5 & P6 plug lengths	04/18/2013

The revision history provided is for informational purposes only and is believed to be accurate.

This device complies with part 15 of the FCC Rules. Operation is subject to the following two conditions:

- (1) This device may not cause harmful interference, and
- (2) this device must accept any interference received, including interference that may cause undesired operation.

CUI offers a one (1) year limited warranty. Complete warranty information is listed on our website.

CUI reserves the right to make changes to the product at any time without notice. Information provided by CUI is believed to be accurate and reliable. However, no responsibility is assumed by CUI for its use, nor for any infringements of patents or other rights of third parties which may result from its use.

CUI products are not authorized or warranted for use as critical components in equipment that requires an extremely high level of reliability. A critical component is any component of a life support device or system whose failure to perform can be reasonably expected to cause the failure of the life support device or system, or to affect its safety or effectiveness.



Headquarters
20050 SW 112th Ave.
Tualatin, OR 97062
800.275.4899

Fax 503.612.2383
cui.com
techsupport@cui.com